

ASSEMBLY INSTRUCTION

OPERATING INSTRUCTION

1

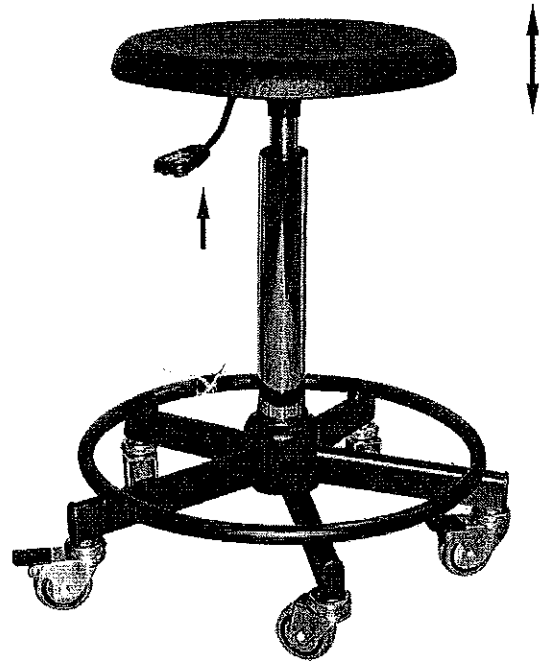
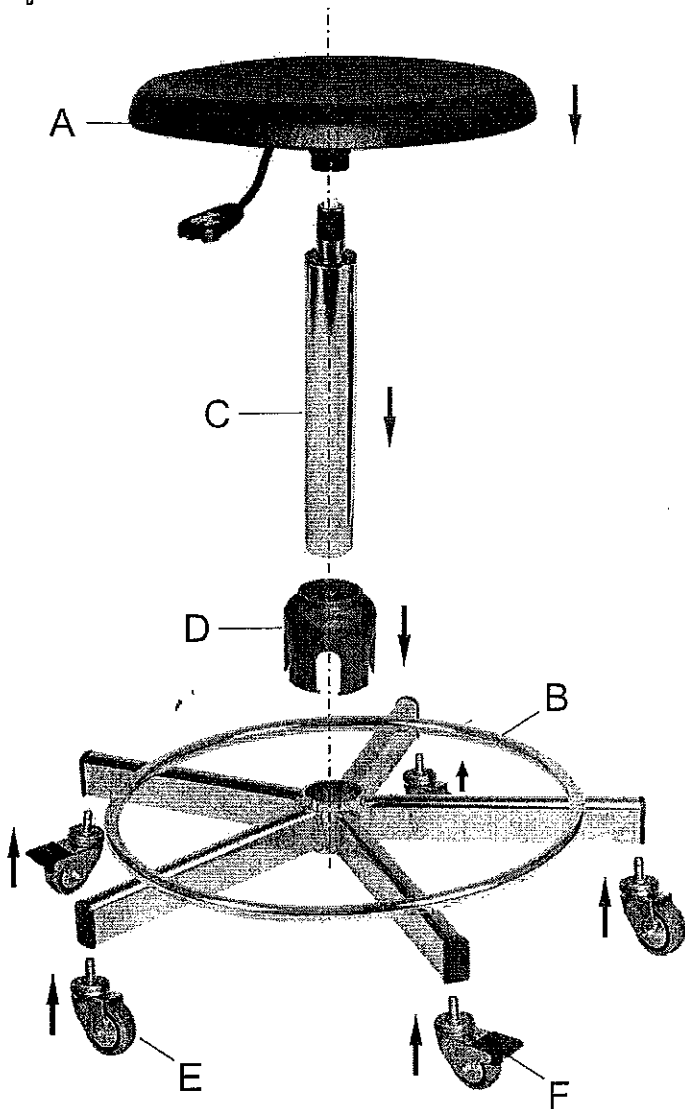

Height adjustment of the seat

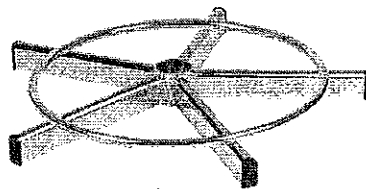

A x1

B x1

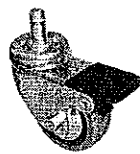
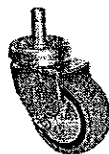

C x1

D x1

E x3

F x2

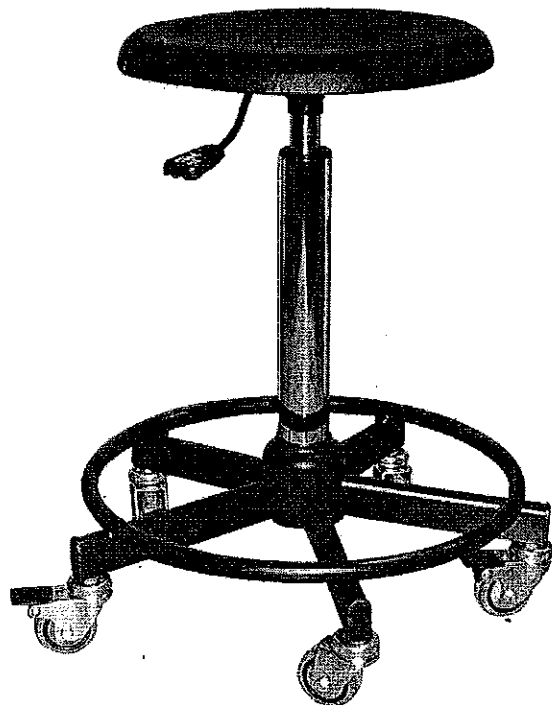

ASSEMBLY INSTRUCTION

1

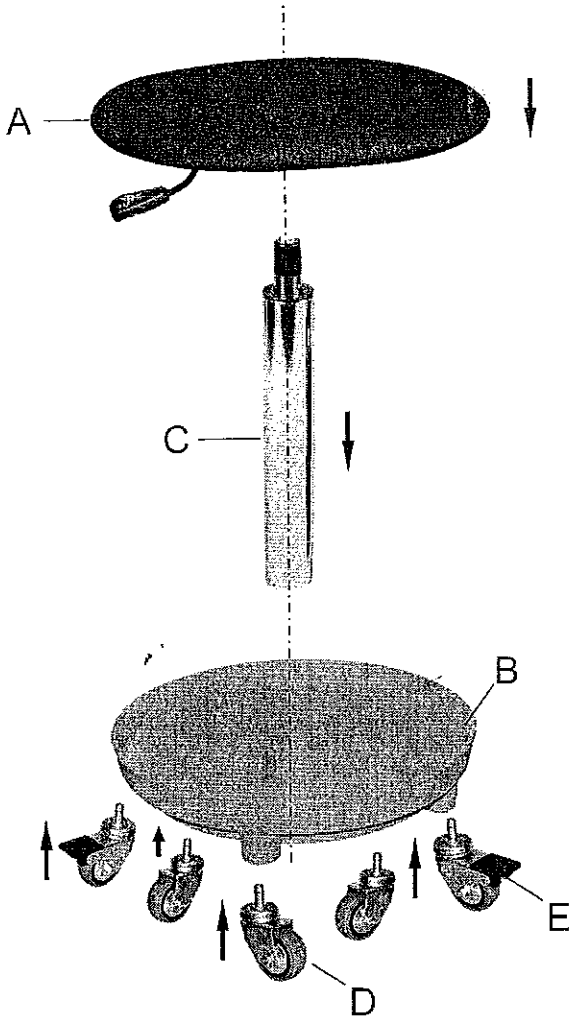

OPERATING INSTRUCTION

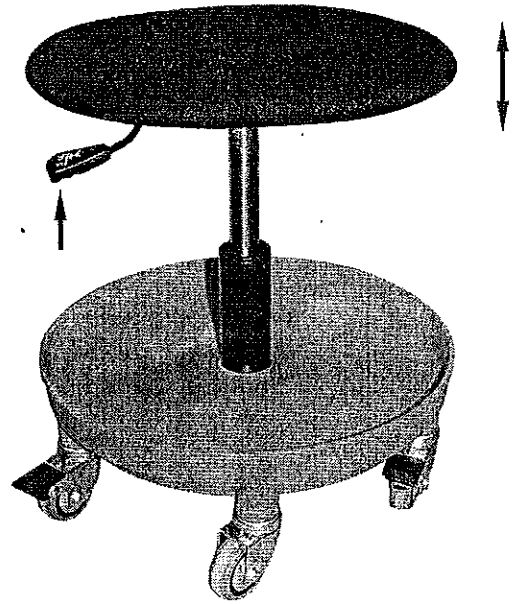

Height adjustment of the seat

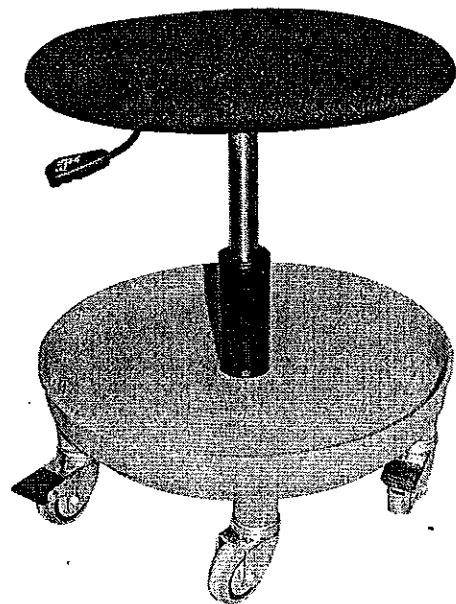

A x1

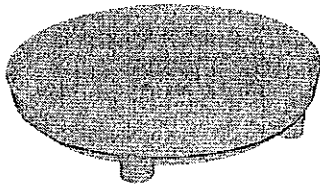

B x1



C x1

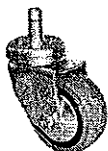

D x3



E x2

ASSEMBLY INSTRUCTION

OPERATING INSTRUCTION

1

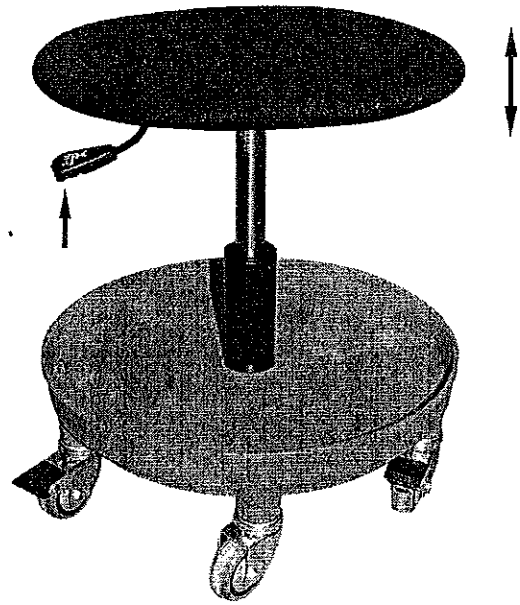
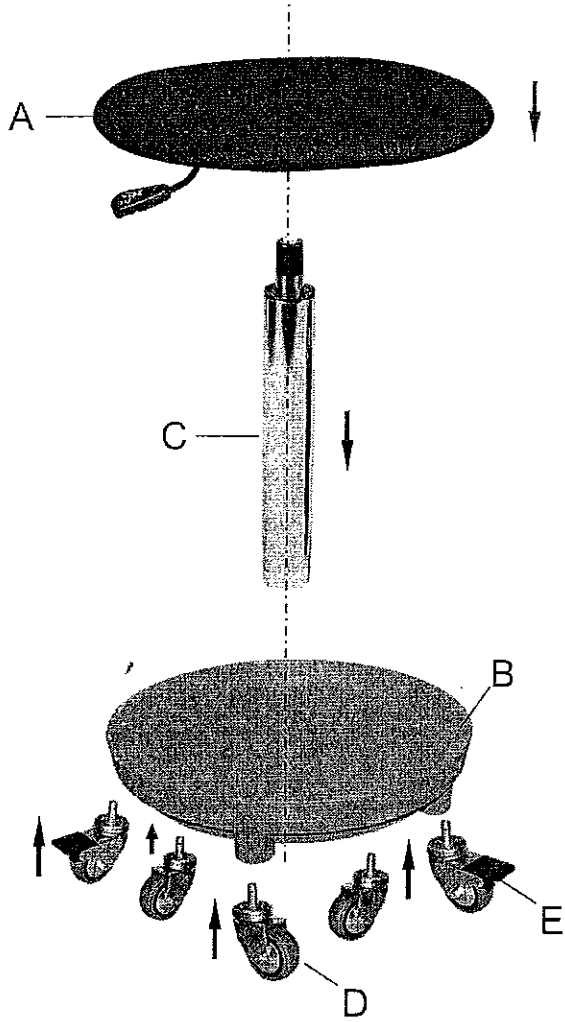

Height adjustment of the seat

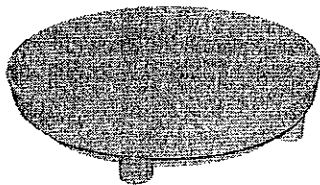

A x1

B x1

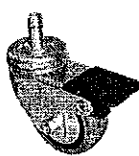
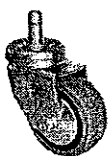

C x1

D x3

E x2

